

- [54] **AIRCRAFT**
- [75] **Inventors: Irving T. Waaland, Verdes Estates; John F. Cashen, Rancho Palos Verdes; James E. Kinnu, Orange, all of Calif.**
- [73] **Assignee: Northrop Corporation, Hawthorne, Calif.**
- [\*\*] **Term: 14 Years**
- [21] **Appl. No.: 341,106**
- [22] **Filed: Apr. 19, 1989**
- [52] **U.S. Cl. .... D12/333; D12/319; D12/342**
- [58] **Field of Search ..... D12/319, 333, 342, 331; 244/215**

- D. 143,863 2/1946 Northrop ..... D12/333
- D. 143,865 2/1946 Northrop et al. .... D12/333
- D. 143,867 2/1946 Northrop ..... D12/333
- D. 143,868 2/1946 Northrop ..... D12/333
- D. 143,869 2/1946 Northrop ..... D12/333
- D. 143,870 2/1946 Northrop ..... D12/333
- D. 143,871 2/1946 Northrop ..... D12/333
- D. 143,872 2/1946 Northrop ..... D12/333
- D. 143,873 2/1946 Northrop ..... D12/333
- D. 143,874 2/1946 Northrop ..... D12/333
- D. 149,666 5/1948 Northrop et al. .... D12/333
- D. 149,848 6/1948 Struck ..... D21/89
- D. 204,331 4/1966 Robins et al. .... D12/333
- D. 208,678 9/1967 Schairer ..... D12/333
- D. 240,437 7/1976 Rizzo ..... D21/87
- D. 279,492 7/1985 Eddins et al. .... D21/89
- D. 281,680 12/1985 Henderson ..... D12/333
- 2,406,506 8/1946 Northrop ..... 244/215

[56] **References Cited**

**U.S. PATENT DOCUMENTS**

- D. 127,185 5/1941 Northrop ..... D12/333
- D. 143,706 2/1946 Bowers ..... D12/333
- D. 143,848 2/1946 Northrop ..... D12/333
- D. 143,849 2/1946 Northrop ..... D12/333
- D. 143,850 2/1946 Northrop ..... D12/333
- D. 143,851 2/1946 Northrop ..... D12/333
- D. 143,852 2/1946 Northrop ..... D12/333
- D. 143,853 2/1946 Northrop ..... D12/333
- D. 143,854 2/1946 Northrop ..... D12/333
- D. 143,855 2/1946 Northrop ..... D12/333
- D. 143,856 2/1946 Northrop ..... D12/333
- D. 143,857 2/1946 Northrop ..... D12/333
- D. 143,858 2/1946 Northrop ..... D12/333
- D. 143,859 2/1946 Northrop ..... D12/333
- D. 143,860 2/1946 Northrop ..... D12/333
- D. 143,861 2/1946 Northrop ..... D12/333
- D. 143,862 2/1946 Northrop ..... D12/333

**OTHER PUBLICATIONS**

Popular Mechanics, Jan. 1987, "Wing Ding".

*Primary Examiner*—Kay H. Chin

*Attorney, Agent, or Firm*—Terry J. Anderson; Robert B. Block

[57] **CLAIM**

The ornamental design for an aircraft, as shown and described.

**DESCRIPTION**

FIG. 1 is a top perspective view of an aircraft showing our new design;  
 FIG. 2 is a bottom perspective view thereof;  
 FIG. 3 is a top plan view thereof;  
 FIG. 4 is a front elevation view thereof;  
 FIG. 5 is a rear elevation view thereof;  
 FIG. 6 is a left side elevation view thereof, the right side elevation view being a mirror image of that shown.

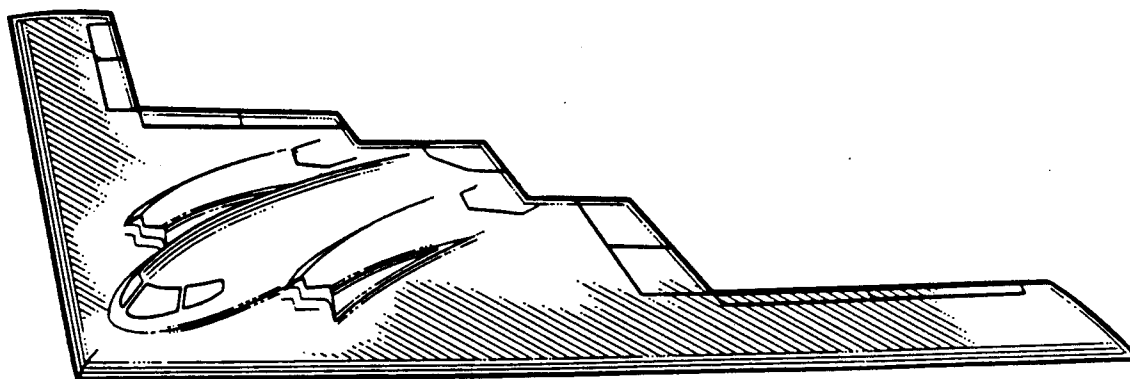

FIG. 1

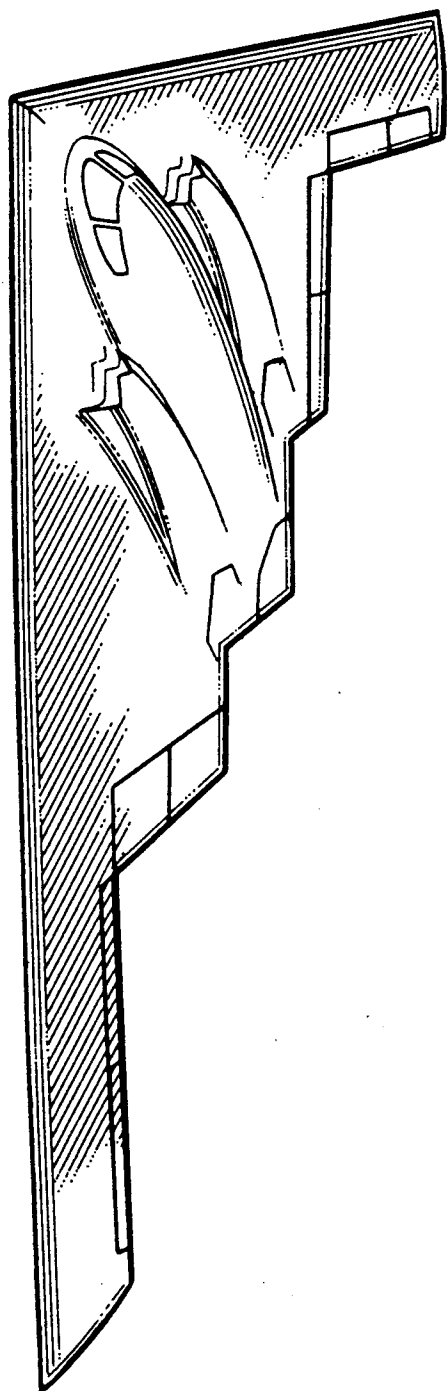
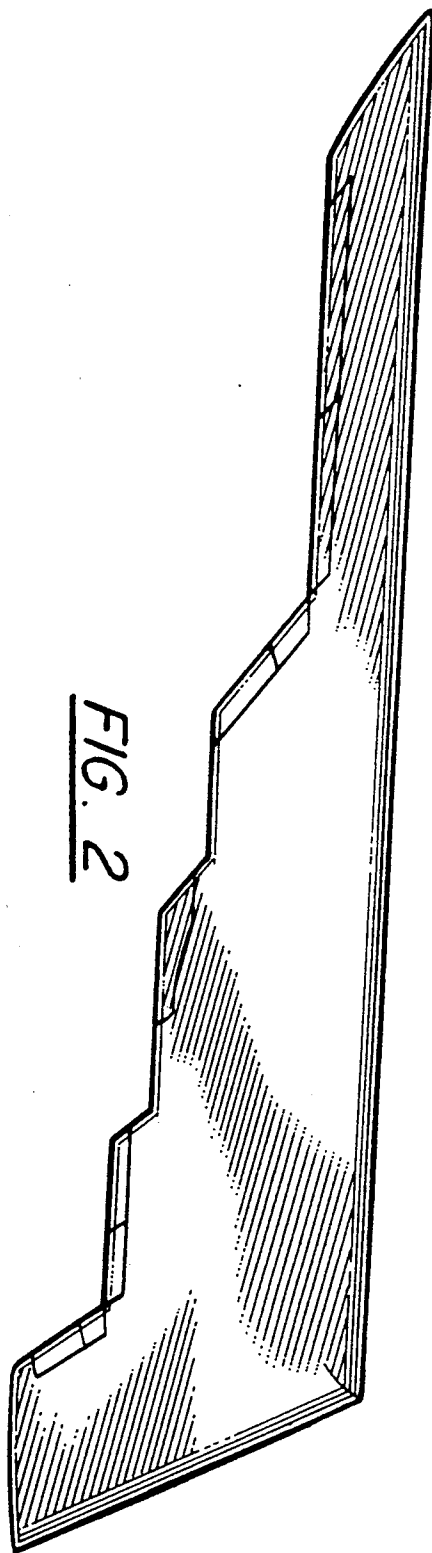

FIG. 2



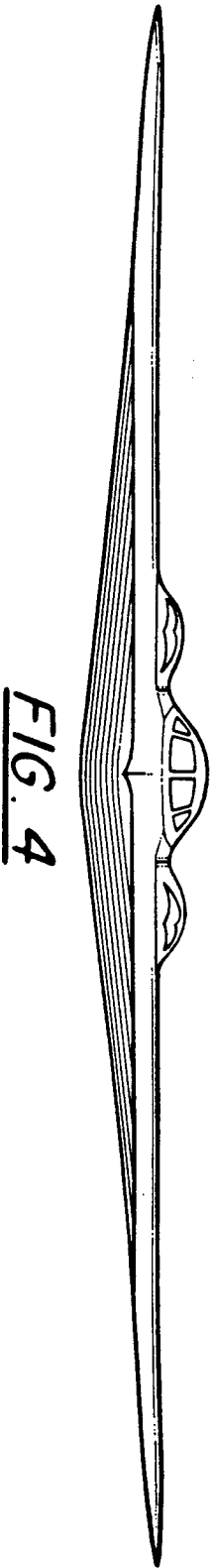

FIG. 4

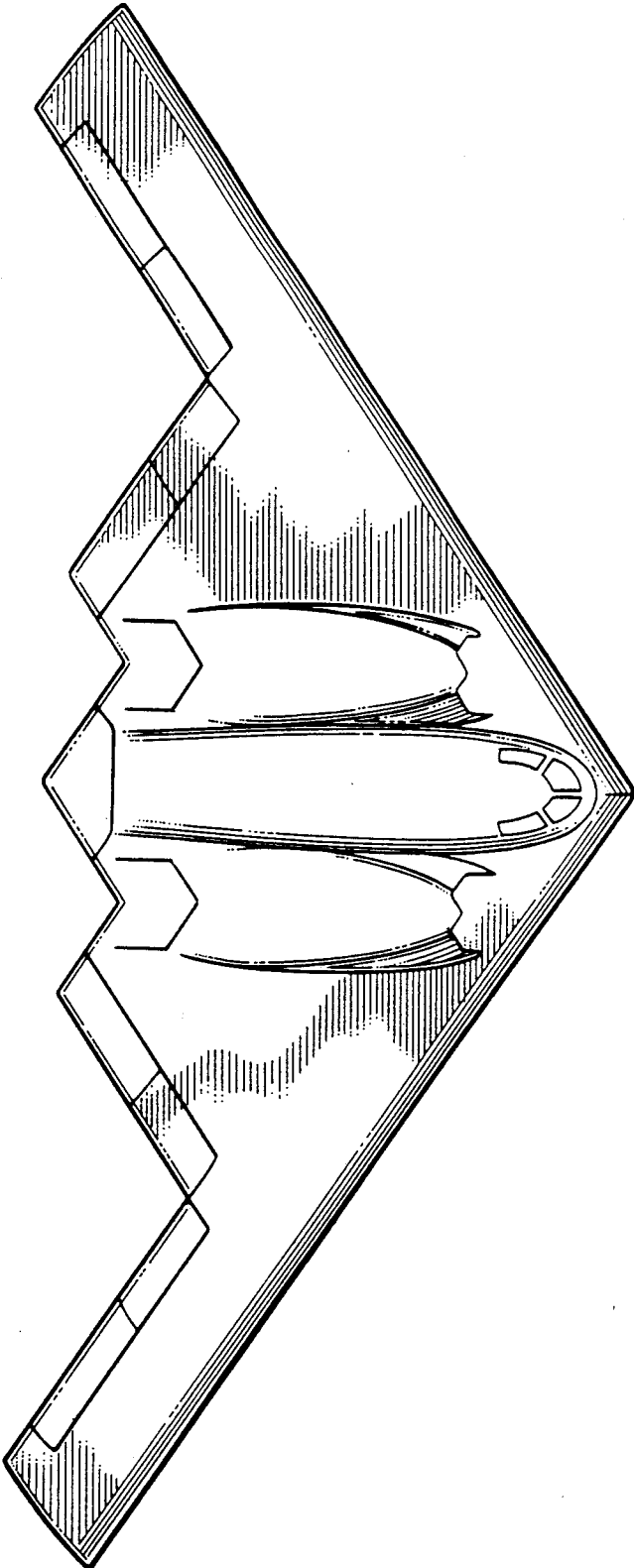

FIG. 3

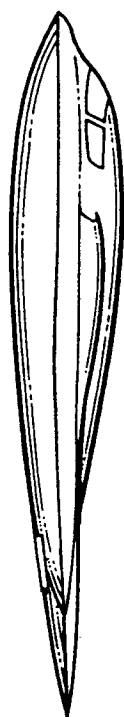

FIG. 6

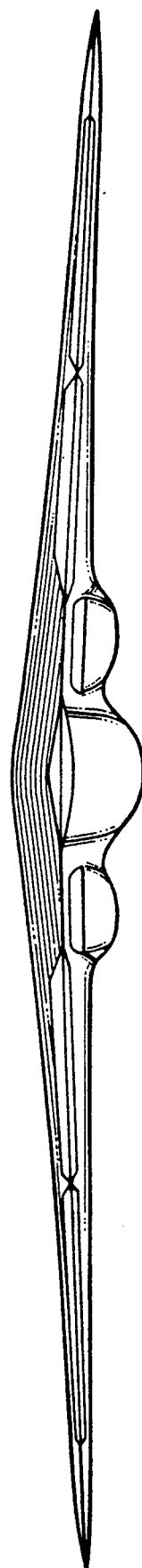

FIG. 5